



Journey

4 COLOURS

4 SIZES

3 SURFACES

Interpreted as a journey through the landscapes of Northern Europe, Journey is the synthesis of all those characteristics that allow to define welcoming and natural areas able to express, through colors, surfaces, sizes and decorations, the contemporary taste of the world of interior design.

CERAMICHE **PIEMME**
FLOOR AND MORE

Interpretata come un viaggio attraverso i paesaggi del Nord Europa, Journey è la sintesi di tutte quelle caratteristiche che permettono di definire spazi accoglienti e naturali in grado di esprimere, attraverso colori, superfici, formati e decori, i gusti contemporanei del mondo dell'interior design.

Journey ist die Synthese all jener Eigenschaften einer Reise durch die Landschaften Nordeuropas, die es ermöglichen, einladende und natürliche Räume zu definieren, die in der Lage sind, durch Farben, Oberflächen, Formate und Dekorationen den zeitgenössischen Geschmack der Innenarchitektur auszudrücken.

Interprétée comme un voyage à travers les paysages de l'Europe du Nord, la série Journey est la synthèse de toutes les caractéristiques qui permettent de définir des espaces accueillants et naturels en mesure d'exprimer, à travers des couleurs, des surfaces, formats et décors, les goûts contemporains du monde du design d'intérieur.

Journey



Technology

P. 5

Spazi Pubblici
Public Areas

P. 13

Spazi Residenziali
Residential Spaces

P. 33

Informazioni Tecniche
Technical Information

P. 53



JOURNEY

In continuità con la propria vocazione di saper cogliere l'essenza dei materiali lapidei, Ceramiche Piemme presenta la collezione Journey in quattro colori, quattro formati, quattro strutture e tre finiture, introducendo per la prima volta **una superficie denominata Silk, dalla sensazione tattile extra morbida.** Completano la gamma la superficie naturale e antislip, che riproduce l'effetto estetico del taglio sega delle lastre di pietra.

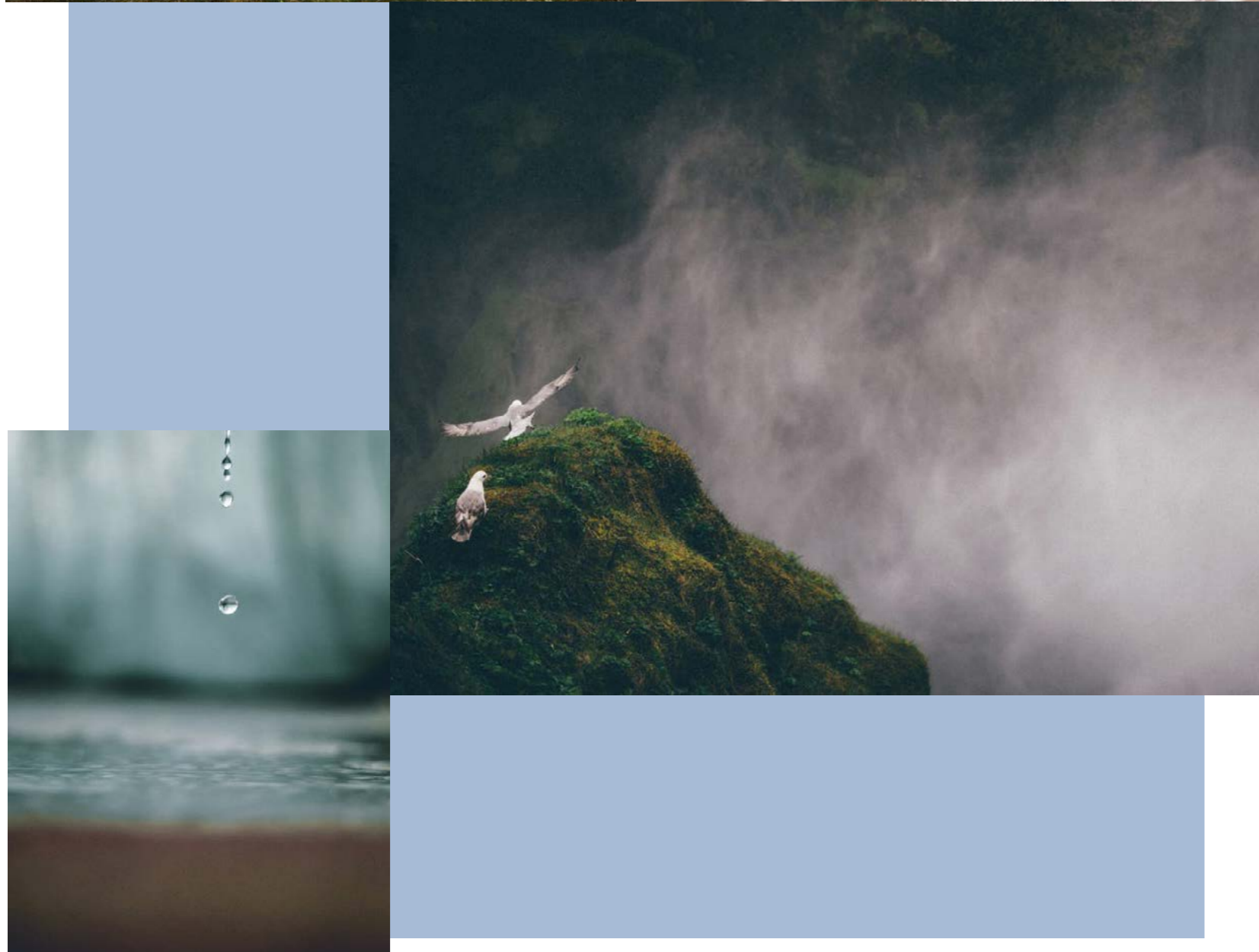

In continuity with one's vocation to be able to grasp the essence of stone materials, Ceramiche Piemme presents the Journey collection in four colors, four sizes, four structures and three finishes, introducing for the first time **a surface called Silk, with an extra soft tactile sensation.**

The range is completed by a natural and anti-slip surface, which reproduces the aesthetic effect of the saw cut of the stone slabs.

Mit der Berufung, die Essenz von Steinmaterialien zu erfassen, präsentiert Ceramiche Piemme die Journey-Kollektion in vier Farben, vier Größen, vier Strukturen und drei Ausführungen und stellt zum ersten Mal **eine Oberfläche namens Silk mit einem besonders weichen Tastgefühl.**

Das Sortiment wird mit einer natürlichen und rutschhemmenden Oberfläche, die die ästhetische Wirkung des Sägeschnitts der Steinplatten wiedergibt, ergänzt.

En continuité avec sa vocation de savoir saisir l'essence des matériaux pierreux, Ceramiche Piemme présente la Collection Journey en quatre couleurs, quatre formats, quatre structures et trois finitions, introduisant pour la première fois **une surface appelée Silk, avec une sensation tactile extra douce.**

La gamme est complétée par la surface naturelle et antislip, qui reproduit l'effet esthétique de la coupe à la scie des dalles en pierre.

Technology

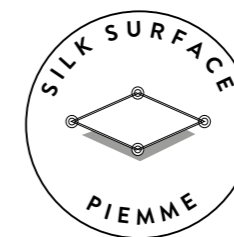

Una nuova superficie
A new surface
Eine neue Oberfläche
Une nouvelle surface



Una Tecnologia Rivoluzionaria
A Revolutionary Technology
Eine revolutionäre Technologie
Une Technologie Révolutionnaire

PAGINA / PAGE

Silk Surface 6

Antislip Surface / Synchro Digit Piemme® 8

Three-dimensional Relief Decorations / Synchro Digit Piemme® 10

Journey Technology 5

Silk Surface

The new surface called Silk, obtained by a particular lapping, is characterized by an extra soft tactile sensation and a light opaque reflection, easy to clean, due to the absence of surface roughness, is able to create environments with warm and embracing atmospheres.

Die neue Oberfläche namens Silk, die durch eine besondere Läppung erhalten wird, zeichnet sich durch ein besonders weiches Tastgefühl und eine matte Lichtreflexion aus und ist leicht zu reinigen, da keine Oberflächenrauheit besteht; außerdem schafft sie Umgebungen mit warmen und einhüllenden Atmosphären.

La nouvelle surface dénommée Silk obtenue d'un polissage particulier, est caractérisée d'une sensation tactile extra douce et d'un reflet mat de lumière, facile à nettoyer grâce à l'absence de rugosité superficielle, elle est en mesure de créer des environnements aux atmosphères chaudes et enveloppantes.

La nuova superficie denominata Silk ottenuta da una particolare lappatura, è caratterizzata da una sensazione tattile extra morbida e da una riflessione opaca della luce, facile da pulire, data l'assenza di ruvidità superficiale, è in grado di creare ambienti dalle atmosfere calde e avvolgenti.

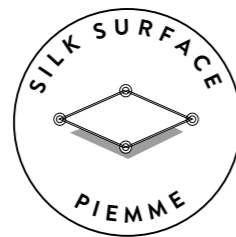

60x120 - 24"x48" Cumbria Silk Rettificato

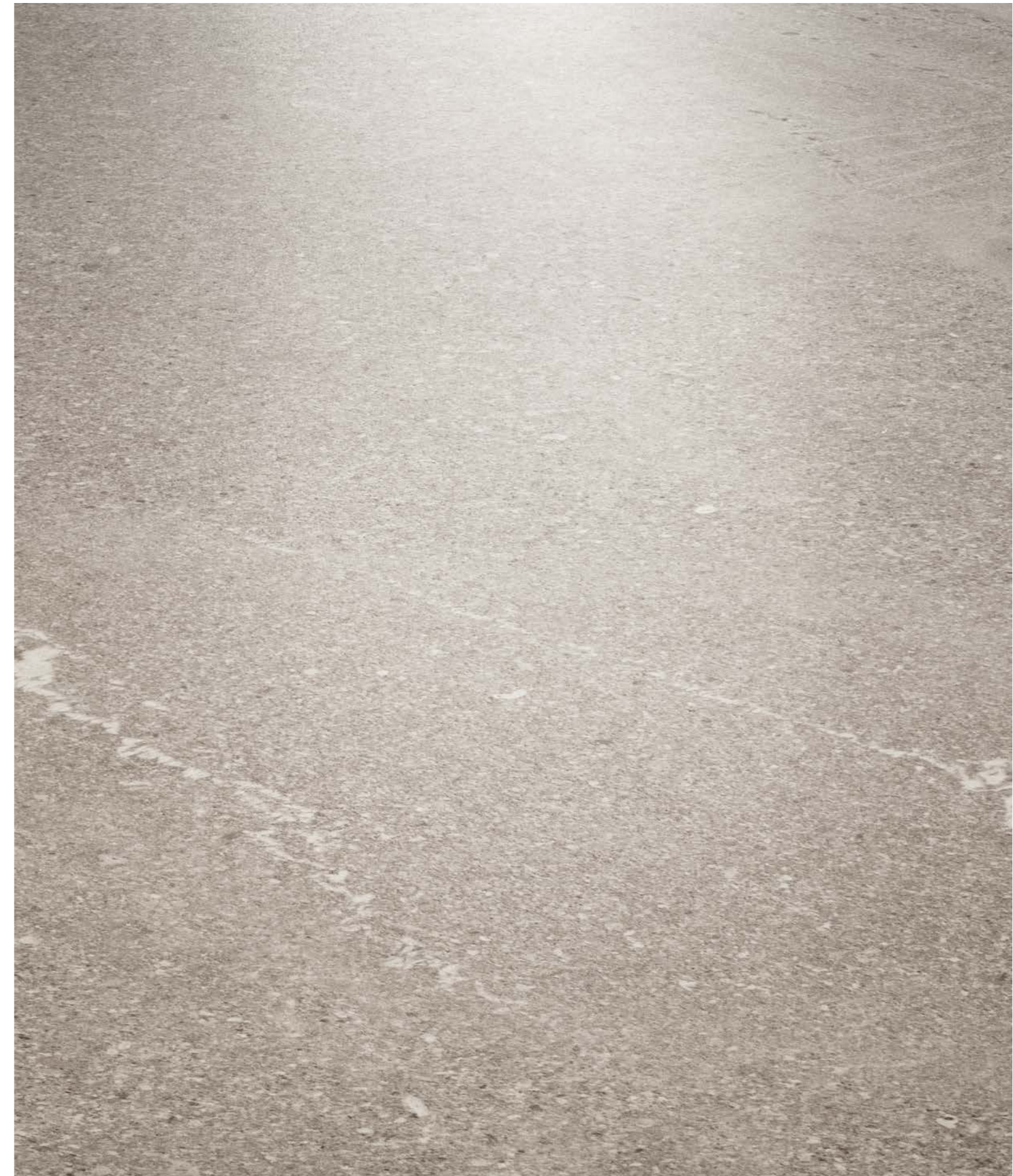

Journey
Silk Surface

Antislip Surface / Synchro Digit Piemme®

The surface with a synchronized digital structure Synchro Digit Piemme® allows to reproduce the typical aesthetic effect of the saw cut of natural stones, ensuring a soft surface with a high slip resistance.

Die Oberfläche mit synchronisierter digitaler Struktur von Synchro Digit Piemme® ermöglicht es, die typische ästhetische Wirkung des Sägeschnitts von Naturstein darzustellen und sorgt für eine weiche Oberfläche, aber mit hoher Rutschfestigkeit.

La surface avec structure numérique synchronisée Synchro Digit Piemme® permet de reproduire l'effet esthétique typique de la coupe de scie des pierres naturelles, garantissant une surface douce mais avec une résistance élevée à la glissance.

La superficie con struttura digitale sincronizzata Synchro Digit Piemme®, consente di riprodurre l'effetto estetico tipico del taglio sega delle pietre naturali, garantendo una superficie morbida ma con un'elevata resistenza allo scivolamento.



60x120 - 24"x48" Cumbria Antislip Rettificato



Journey
Antislip Surface / Synchro Digit Piemme®

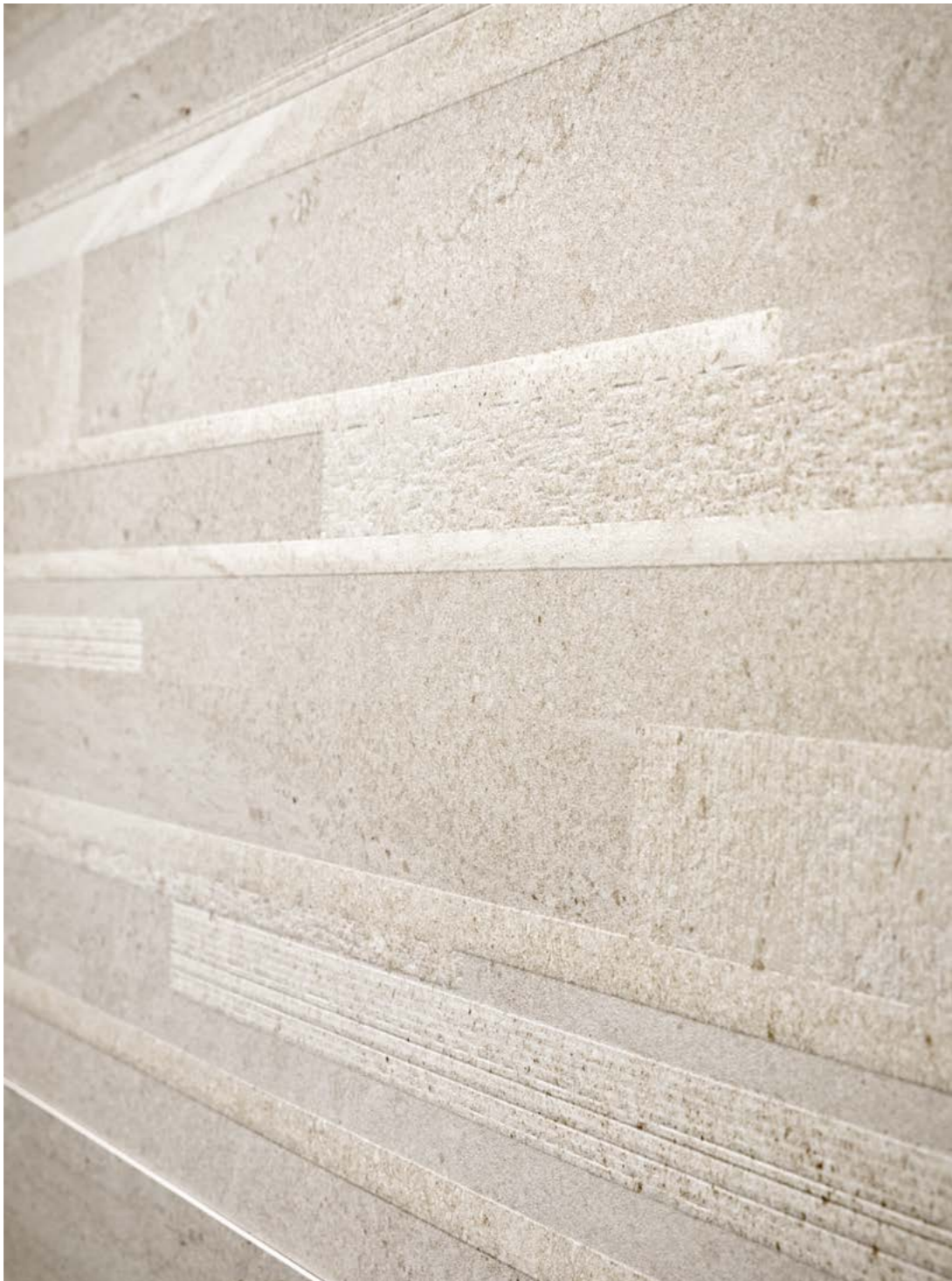

Spazi Pubblici

Public Areas
Öffentliche Räumlichkeiten
Espaces Publics



COLORI / COLOURS

AMBIENTI / AMBIENT

PAGINA / PAGE

Cumbria / Tetris Cold

Hall

14

Lomond

Coffee Shop

18

Otta / Lomond

Gym

22

Sarek

Swimming pool

26

Sarek / Otta

Wellness Area

30

Cumbria / Tetris Cold

60x120 - 24"x48" Tetris Cold Naturale Rettificato
60x120 - 24"x48" Cumbria Naturale Rettificato



120x120 - 48"x48" Cumbria Naturale Rettificato

20x120 - 8"x48" Fleur de Bois Brun Naturale Rettificato



Cumbria / Tetris Cold

The Tetris décor, also used as floor tile, contributes to create refined and original environments.

Das Dekor Tetris, auch als Bodenplatte verlegt, trägt dazu bei, raffinierte und originelle Umgebungen zu schaffen.

Le décor Tetris, posé au sol contribue à créer des environnements recherchés et originaux.

Il decoro Tetris, posato anche a pavimento contribuisce a creare ambienti dallo stile ricercato e originale.

120x120 - 48"x48" Cumbria Naturale Rettificato

60x120 - 24"x48" Tetris Cold Naturale Rettificato



Journey
Public Areas



Lomond

The size 120x120 completes the rich range of surfaces and structures with 60x120, 60x60 and 30x60 sizes. The ideal aesthetic choice in public areas with a contemporary taste.

Das Format 120x120 vervollständigt das Sortiment, mit vielen Oberflächen und Strukturen in den Formaten 60x120, 60x60 und 30x60. Die ideale ästhetische Wahl in öffentlichen Räumen mit zeitgemäßem Geschmack.

Le format 120x120 complète la gamme, riche de surfaces et de structures dans les formats 60x120, 60x60 et 30x60. Le choix esthétique idéal dans les espaces publics au goût contemporain.

Il formato 120x120 completa la gamma, ricca di superfici e di strutture nei formati 60x120, 60x60 e 30x60. La scelta estetica ideale negli spazi pubblici dal gusto contemporaneo.

120x120 - 48"x48" Lomond Naturale Rettificato

60x120 - 24"x48" Scratch Lomond Naturale Rettificato







Sarek

The antislip surface, while maintaining a soft tactile sensation, responds perfectly to the imposed friction parameters by international regulations, therefore it constitutes the suitable choice for projects of public and commercial areas, including outdoor wellness and hospitality areas.

Die rutschfeste Oberfläche reagiert, trotz dem weichen Tastgefühl, perfekt auf die international vorgeschriebenen Abreibungsnormen und ist daher die ideale Wahl für Objekte in öffentlichen und gewerblichen Bereichen, einschließlich Wellness und Hospitality im Freien.

La surface antislip, tout en gardant une sensation tactile douce, répond parfaitement aux paramètres de friction imposés par les réglementations internationales, donc constitue le choix approprié pour des projets de zones publiques et commerciales, y compris zones en plein air wellness et hospitality.

La superficie antislip, pur mantenendo una sensazione tattile morbida, risponde perfettamente ai parametri di attrito imposti dalle normative Internazionali, pertanto costituisce la scelta idonea per progetti di aree pubbliche e commerciali, comprese le aree outdoor, wellness e hospitality.

60×120 - 24"×48" Sarek Antislip Rettificato







Spazi Residenziali

Residential Spaces
Wohnanlagen
Espaces Résidentiels



COLORI / COLOURS

AMBIENTI / AMBIENT

PAGINA / PAGE

Lomond / Cumbria

Kitchen

34

Cumbria / Flute Lomond

Living

38

Sarek

Bedroom

42

Otta / Tetris Warm

Bathroom

46

Cumbria

Outdoor

50

Journey
Residential Spaces

33



Thanks to the versatility of the three surfaces, Silk, natural and antislip, the products of the Journey collection permit the use in different communicating areas, internal and external, ensuring the maximum planning flexibility.

Die Produkte der Journey-Kollektion ermöglichen, dank der Vielseitigkeit der drei Oberflächen Silk, Natürlich und Rutschfest, den Einsatz in unterschiedlichen, aber kommunizierenden Räumen wie Innen- und Außenbereiche und gewährleisten maximale Gestaltungsflexibilität.

Les produits de la collection Journey, grâce à la polyvalence des ses trois surfaces Silk, naturel et antislip, permettent l'utilisation dans des espaces différents mais communicants comme intérieurs et extérieurs en garantissant une flexibilité maximale de conception.

I prodotti della collezione Journey, grazie alla versatilità delle tre superfici Silk, naturale e antislip, consentono l'uso in spazi differenti ma comunicanti come interni ed esterni garantendo la massima flessibilità progettuale.







Sarek

The new Silk surface, silky and refined, responds to current design trends to create welcoming and relaxing atmospheres.

Die neue seidige und raffinierte Oberfläche Silk reagiert auf aktuelle Designtrends, um einladende und entspannende Atmosphären zu schaffen.

La nouvelle surface Silk, soyeuse et raffinée, répond aux tendances actuelles du design permettant de créer des atmosphères accueillantes et relaxantes

La nuova superficie Silk, setosa e raffinata, risponde alle tendenze attuali del design di creare atmosfere accoglienti e rilassanti.

60x120 - 24"x48" Sarek Silk Rettificato







Otta

Natural shades and subtle veins characterize Journey, whose nuances offer the opportunity to create warm and comfortable areas.

Natürliche Farbtöne und schmale Äderungen zeichnen Serie Journey aus, dessen Nuancen die Möglichkeit bieten, warme und behagliche Räume zu schaffen.

Teintes naturelles et veines fines caractérisent Journey, dont les nuances offrent la possibilité de créer des espaces chauds et confortables.

Tonalità naturali e sottili venature caratterizzano Journey, le cui nuances offrono l'opportunità di creare spazi caldi e confortevoli.

60x120 - 24"x48" Otta Naturale Rettificato





Informazioni Tecniche

4

Colori
Colours
Farben
Couleurs



4

Formati
Sizes
Formate
Formats

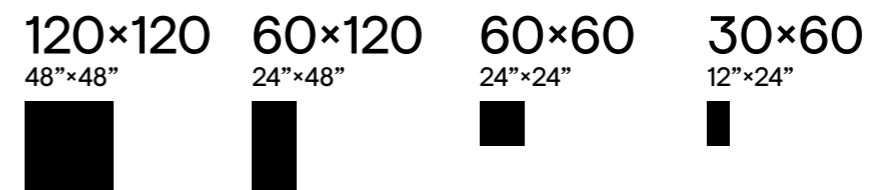

2

Spessori
Thickness
Stärke
Epaisseur

±9 ±9,5

3

Superfici
Surfaces
Oberflächen
Surfaces

Naturale Silk Antislip

4

Strutture 3D
3D structures
Strukturen
Décorations en relief

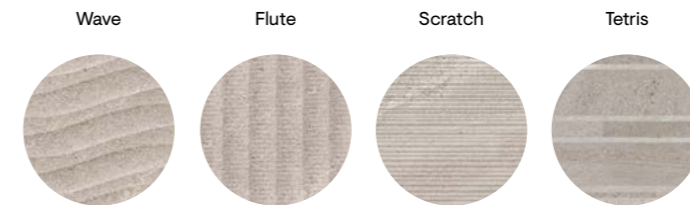

i



Tecnologia - Technology - Technologie:
Synchro Digit Piemme™
Superficie con struttura digitale sincronizzata
Synchronized digital structured surface
Im synchronisierten Digitaldruckverfahren
hergestellte 3D-Oberfläche
Surface avec texture et finition par
impression numérique synchronisée

Gres fine porcellanato ad impasto colorato
Coloured-body fine porcelain stoneware
Feinsteinzeug aus farbiger Masse
Grès cérame fin à pâte colorée

Effetto Pietra
Stone Look
Natursteinoptik
Effet Pierre

Rivestimento
Wall Tiles
Wandfliesen
Revêtement

Pavimento
Floor Tiles
Bodenfliesen
Sol



Otta

Per un risultato di posa ottimale si consiglia di prelevare le piastrelle da 5/6 scatole contemporaneamente.

For best installation results, we suggest taking the tiles from 5/6 boxes at the same time.



± 9

120x120 - 48"x48"

04953 | Journey Otta Nat/Ret
05299 | Journey Otta Silk/Ret



± 9,5

60x60 - 24"x24"

04717 | Journey Otta Nat/Ret
04722 | Journey Otta Silk/Ret



± 9,5

30x60 - 12"x24"

04726 | Journey Otta Nat/Ret
04731 | Journey Otta Silk/Ret



± 9,5

60x120 - 24"x48"

04671 | Journey Otta Nat/Ret
04678 | Journey Otta Silk/Ret



60x120 - 24"x48"

04688 | Journey Scratch Otta Nat/Ret
(Synchro Digit Piemme Technology)



30x60 - 12"x24"

04735 | Journey Wave Otta Nat/Ret



± 9,5

60x120 - 24"x48"

***04697** | Journey Otta Antislip/Ret
(Synchro Digit Piemme Technology)



60x120 - 24"x48"

04687 | Journey Tetris Warm Nat/Ret
(Synchro Digit Piemme Technology)



30x60 - 12"x24"

04739 | Journey Flute Otta Nat/Ret

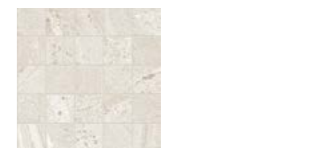

30x30 - 12"x12"

04937 | Journey Mosaico Otta Nat/Ret

*L'articolo non ha verso di posa
Item with no laying direction
Artikel ohne Verlegerichtung
Article sans sens de pose

Pezzi speciali
Special pieces

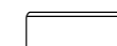

Battiscopa 4,5x60 ± 9,5

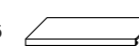

Gradino Costa Retta 33x120 ± 9,5



Gres fine porcellanato ad impasto colorato
Tecnologia Digitale

Coloured-body fine porcelain stoneware
Digital Technology

Feinsteinzeug aus farbiger Masse
Digital Technologie

Grès cérame fin à pâte colorée
Technologie Numérique

Sarek

Per un risultato di posa ottimale si consiglia di prelevare le piastrelle da 5/6 scatole contemporaneamente.

For best installation results, we suggest taking the tiles from 5/6 boxes at the same time.



± 9

120x120 - 48"x48"

04954 | Journey Sarek Nat/Ret
05301 | Journey Sarek Silk/Ret



± 9,5

60x60 - 24"x24"

04718 | Journey Sarek Nat/Ret
04723 | Journey Sarek Silk/Ret



± 9,5

30x60 - 12"x24"

04727 | Journey Sarek Nat/Ret
04732 | Journey Sarek Silk/Ret



± 9,5

60x120 - 24"x48"

04673 | Journey Sarek Nat/Ret
04681 | Journey Sarek Silk/Ret



60x120 - 24"x48"

04689 | Journey Scratch Sarek Nat/Ret
(Synchro Digit Piemme Technology)



30x60 - 12"x24"

04736 | Journey Wave Sarek Nat/Ret



± 9,5

60x120 - 24"x48"

***04699** | Journey Sarek Antislip/Ret
(Synchro Digit Piemme Technology)



60x120 - 24"x48"

04687 | Journey Tetris Warm Nat/Ret
(Synchro Digit Piemme Technology)



30x60 - 12"x24"

04741 | Journey Flute Sarek Nat/Ret

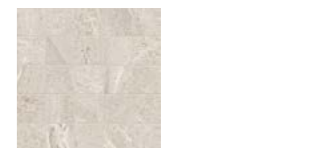

30x30 - 12"x12"

04938 | Journey Mosaico Sarek Nat/Ret

*L'articolo non ha verso di posa
Item with no laying direction
Artikel ohne Verlegerichtung
Article sans sens de pose

Pezzi speciali
Special pieces



Battiscopa 4,5x60 ± 9,5

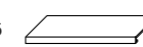

Gradino Costa Retta 33x120 ± 9,5



Cumbria

Per un risultato di posa ottimale si consiglia di prelevare le piastrelle da 5/6 scatole contemporaneamente.

For best installation results, we suggest taking the tiles from 5/6 boxes at the same time.



± 9

120x120 - 48"x48"

04955 | Journey Cumbria Nat/Ret
05302 | Journey Cumbria Silk/Ret



± 9,5

60x60 - 24"x24"

04719 | Journey Cumbria Nat/Ret
04724 | Journey Cumbria Silk/Ret



± 9,5

30x60 - 12"x24"

04728 | Journey Cumbria Nat/Ret
04733 | Journey Cumbria Silk/Ret



± 9,5

60x120 - 24"x48"

04674 | Journey Cumbria Nat/Ret
04682 | Journey Cumbria Silk/Ret



60x120 - 24"x48"

04691 | Journey Scratch Cumbria Nat/Ret
(Synchro Digit Piemme Technology)



30x60 - 12"x24"

04737 | Journey Wave Cumbria Nat/Ret



± 9,5

60x120 - 24"x48"

***04701** | Journey Cumbria Antislip/Ret
(Synchro Digit Piemme Technology)



60x120 - 24"x48"

04685 | Journey Tetris Cold Nat/Ret
(Synchro Digit Piemme Technology)



30x60 - 12"x24"

04742 | Journey Flute Cumbria Nat/Ret



30x30 - 12"x12"

04939 | Journey Mosaico Cumbria Nat/Ret

*L'articolo non ha verso di posa
Item with no laying direction
Artikel ohne Verlegerichtung
Article sans sens de pose

Pezzi speciali
Special pieces

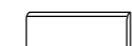

Battiscopa 4,5x60 ± 9,5

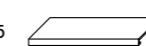

Gradino Costa Retta 33x120 ± 9,5

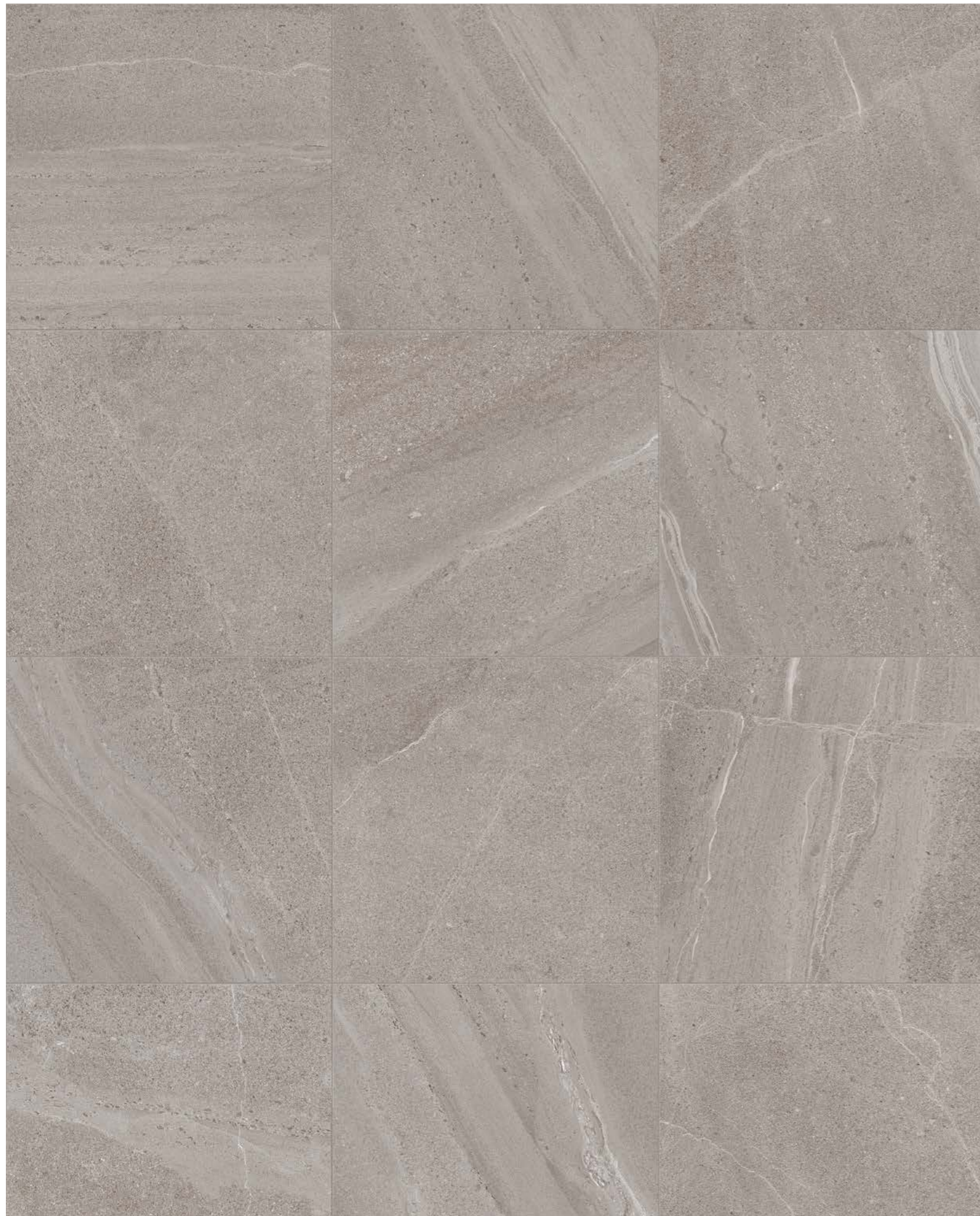

Gres fine porcellanato ad impasto colorato
Tecnologia Digitale

Coloured-body fine porcelain stoneware
Digital Technology

Feinsteinzeug aus farbiger Masse
Digital Technologie

Grès cérame fin à pâte colorée
Technologie Numérique

Lomond

Per un risultato di posa ottimale si consiglia di prelevare le piastrelle da 5/6 scatole contemporaneamente.

For best installation results, we suggest taking the tiles from 5/6 boxes at the same time.



± 9

120x120 - 48"x48"

04956 | Journey Lomond Nat/Ret
05303 | Journey Lomond Silk/Ret



± 9,5

60x60 - 24"x24"

04721 | Journey Lomond Nat/Ret
04725 | Journey Lomond Silk/Ret



± 9,5

30x60 - 12"x24"

04729 | Journey Lomond Nat/Ret
04734 | Journey Lomond Silk/Ret



± 9,5

60x120 - 24"x48"

04676 | Journey Lomond Nat/Ret
04683 | Journey Lomond Silk/Ret



60x120 - 24"x48"

04693 | Journey Scratch Lomond Nat/Ret
(Synchro Digit Piemme Technology)

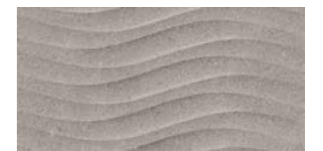

30x60 - 12"x24"

04738 | Journey Wave Lomond Nat/Ret

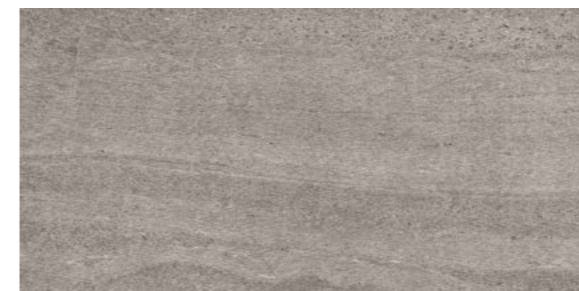

± 9,5

60x120 - 24"x48"

***04705** | Journey Lomond Antislip/Ret
(Synchro Digit Piemme Technology)



60x120 - 24"x48"

04685 | Journey Tetris Cold Nat/Ret
(Synchro Digit Piemme Technology)



30x60 - 12"x24"

04743 | Journey Flute Lomond Nat/Ret



30x30 - 12"x12"

04940 | Journey Mosaico Lomond Nat/Ret

* L'articolo non ha verso di posa
Item with no laying direction
Artikel ohne Verlegerichtung
Article sans sens de pose

Pezzi speciali
Special pieces

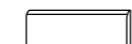



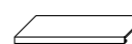

Battiscopa 4,5x60 ± 9,5



Gradino Costa Retta 33x120 ± 9,5







Riepilogo Gamma

Collection
Serie
Gamme

	Formati Sizes	120x120 48"x48"				60x120 24"x48"				60x60 24"x24"				30x60 12"x24"				Strutture 3D 3D Structures					Pezzi Speciali Special Pieces	
		120x120 48"x48"	60x120 24"x48"	60x60 24"x24"	30x60 12"x24"	DIN 51130	DIN 51097	DCOF	BS EN 7976-2	AS 4586 2013	Tetris 60x120 24"x48"	Scratch 60x120 24"x48"	Wave 30x60 12"x24"	Flute 30x60 12"x24"	Mosaico 30x30 12"x12"	Gradino Costa Retta 33x120 13"x48"	Battiscopa 4,5x60 1½"x24"							
		± 9	± 9,5	± 9,5	± 9,5										± 9,5	± 9,5	± 9,5	± 9,5	± 9,5	± 9,5	± 9,5			
 Otta	Nat/Ret	04953	04671	04717	04726	R10	B	>0.42	wet, dry >36	P3	04687	04688	04735	04739	04937	04941	04929							
	Silk/Ret	05299	04678	04722	04731	V2		>0.42								04945	04933							
	Antislip/Ret		04697			R11	A+B+C	>0.42	wet, dry >36	P4														
 Sarek	Nat/Ret	04954	04673	04718	04727	R10	B	>0.42	wet, dry >36	P3	04687	04689	04736	04741	04938	04942	04930							
	Silk/Ret	05301	04681	04723	04732	V2		>0.42								04946	04934							
	Antislip/Ret		04699			R11	A+B+C	>0.42	wet, dry >36	P4														
 Cumbria	Nat/Ret	04955	04674	04719	04728	R10	B	>0.42	wet, dry >36	P3	04685	04691	04737	04742	04939	04943	04931							
	Silk/Ret	05302	04682	04724	04733	V2		>0.42								04947	04935							
	Antislip/Ret		04701			R11	A+B+C	>0.42	wet, dry >36	P4														
 Lomond	Nat/Ret	04956	04676	04721	04729	R10	B	>0.42	wet, dry >36	P3	04685	04693	04738	04743	04940	04944	04932							
	Silk/Ret	05303	04683	04725	04734	V2		>0.42								04948	04936							
	Antislip/Ret		04705			R11	A+B+C	>0.42	wet, dry >36	P4														

Imballi

Packing
Verpackung
Emballage

Formati Sizes	± MM	 Pezzi Scatola Pieces/Box Stck/Karton Carreaux/Boîte	 Mq/Scatola Sqmt/Box Qm/Karton M2/Boîte	 Kg/Scatola Kgs/Box Kg/Karton Kg/Boîte	 Scatole/Paletta Boxes/Pallet Karton/Palette Boîte/Palette	 Mq/Paletta Sqmt/Pallet Qm/Pallet M2/Palette	 Kg/Paletta Kgs/Pallet Kg/Pallet Kg/Palette	 Formato Paletta Size Pallet Format Pallet Dim. Palette
120x120 (48"x48") Nat/Ret - Silk/Ret	P	9	2,880	58,00	22	63,36	1276,00	143x126x67
60x120 (24"x48") Nat/Ret - Silk/Ret - Antislip/Ret	P	9,5	1,440	31,00	30	43,20	930,00	122x80x96
60x60 (24"x24") Nat/Ret - Silk/Ret	P	9,5	1,440	29,00	32	46,08	928,00	120x80x75
30x60 (12"x24") Nat/Ret - Silk/Ret	P	9,5	1,260	25,30	40	50,40	1012,00	120x80x75
60x120 (24"x48") Tetris Nat/Ret	P	9,5	1,440	31,00	30	43,20	930,00	122x80x96
60x120 (24"x48") Scratch Nat/Ret	P	9,5	1,440	31,00	30	43,20	930,00	122x80x96
30x60 (12"x24") Wave Nat/Ret	P	9,5	1,260	26,30	32	40,32	841,60	120x80x75
30x60 (12"x24") Flute Nat/Ret	P	9,5	1,260	26,30	32	40,32	841,60	120x80x75
30x30 (12"x12") Mosaico Nat/Ret	P	9,5	0,45	8,50	60	-	-	-
Pezzi Speciali / Special Pieces								
33x120 (13"x48") Gradino Costa Retta Nat/Ret - Silk/Ret	P	9,5	2	0,792	18,50	20	-	-
4,5x60 (1½"x24") Battiscopa Nat/Ret - Silk/Ret	P	9,5	14	0,378	8,00	80	-	-

Pezzi Speciali

Special pieces
Formstücke
Pièces spéciales

Battiscopa Nat/Ret 4,5×60 – 1¼”×24” ± 9,5
Battiscopa Silk/Ret 4,5×60 – 1¼”×24” ± 9,5

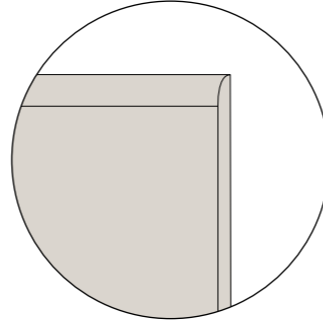
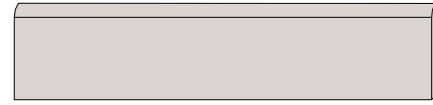

Gradino Costa Retta Nat/Ret 33×120 – 13”×48” ± 9,5
Gradino Costa Retta Silk/Ret 33×120 – 13”×48” ± 9,5
(costa retta ottenuto per taglio e incollaggio - obtained by cutting and gluing)

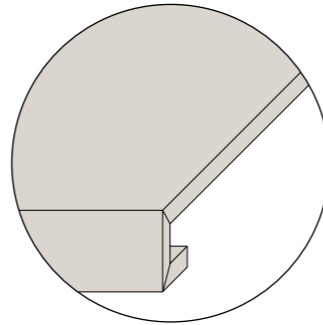

Caratteristiche Tecniche

Technical characteristics
Technische daten
Caracteristiques techniques

CLASSIFICAZIONE SECONDO NORME EN 14411 BI_A – ISO 13006 – CLASSIFICATION IN ACCORDANCE WITH EN 14411 BI_A – ISO 13006
KLASSIFIZIERUNG GEMÄSS NORMEN EN 14411 BI_A – ISO 13006 – CLASSIFICATION SELON LES NORMES EN 14411 BI_A – ISO 13006

CARATTERISTICA TECNICA TECHNICAL CHARACTERISTIC TECHNISCHE DATE CARACTÉRISTIQUE TECHNIQUE	NORMA NORM NORM NORME	VALORE PRESCRITTO VALUE REQUIRED NORMVORGABE VALEUR PRESCRIPTE	VALORE MEDIO MEAN VALUE MITTELWERT VALEUR MOYENNE	NORMA NORM NORM NORME	VALORE MEDIO MEAN VALUE MITTELWERT VALEUR MOYENNE
LUNGHEZZA E LARGHEZZA LENGHT AND WIDTH / LÄNGE UND BREITE / LONGUEUR ET LARGEUR		±0.6% (±2.00 MM)			
SPESSORE THICKNESS / STÄRKE / ÉPAISSEUR		±5% (±0.5 MM)			
RETTILINEITÀ LATI WARPAGES OF EDGES / GERADHEIT DER KANTEN / RÉCITUDE DES ARÊTES	ISO 10545.2	±0.5% (±1.5 MM)	CONFORME IN ACCORDANCE ERFÜLLT CONFORME	ASTM C-499 ASTM C-485 ASTM C-502	IN ACCORDANCE
ORTOGONALITÀ WEDGING / RECHTWINKLIGKEIT / ORTHOGONALITÉ		±0.5% (±2.00 MM)			
PLANARITÀ FLATNESS / PLANITÄT / PLANIMÉTRIE		±0.5% (±2.00 MM)			
ASSORBIMENTO % D'ACQUA WATER ABSORPTION WASSERANNAHME % ABSORPTION D'EAU %	ISO 10545.3	≤ 0.5%	CONFORME IN ACCORDANCE ERFÜLLT CONFORME	ASTM C-373	IN ACCORDANCE
RESISTENZA ALLA FLESSIONE BENDING STRENGTH BIEGEZUGFESTIGKEIT RÉSISTANCE À LA FLEXION	ISO 10545.4	Modulus of rupture (average): R ≥ 35N/mm ² Breaking strength for thickness ≥ 7.5 mm S > 1300 N	CONFORME IN ACCORDANCE ERFÜLLT CONFORME	ASTM C-648 250 LBS OR GREATER	IN ACCORDANCE
DILATAZIONE TERMICA LINEARE TRA 20° E 100° C LINEAR THERMAL EXPANSION BETWEEN 20° AND 100° C LINEARE WÄRMEAUSSDEHNUNG ZWISCHEN 20° UND 100° C DILATATION THERMIQUE LINEAIRE ENTRE 20° ET 100° C	ISO 10545.8	SECONDO I DATI DEL COSTRUTTORE ACCORDING TO BUILDERS SPECIFICATIONS LAUT ANGABEN DES HERSTELLERS SELON LES ELEMENTS DU COSTRUCTEUR	≈ 7X10 ⁻⁶ C ⁻¹		
RESISTENZA AGLI SBALZI TERMICI THERMAL SHOCK RESISTANCE TEMPERATURWECHSELBESTÄNDIGKEIT RÉSISTANCE AUX ÉCARTS DE TEMPÉRATURE	ISO 10545.9	RICHIESTA REQUEST BITTE DEMANDE	RESISTENTE RESISTANT WIDERSTEHEND RÉSISTANT		
RESISTENZA AL GELO FROST RESISTANCE FROSTBESTÄNDIGKEIT RÉSISTANCE AU GEL	ISO 10545.12	RICHIESTA REQUEST BITTE DEMANDE	RESISTENTE RESISTANT WIDERSTEHEND RÉSISTANT	ASTM C-1026	IN ACCORDANCE
RESISTENZA ALL'ATTACCO CHIMICO RESISTANCE TO CHEMICAL ATTACK BESTÄNDIGKEIT GEGEN CHEMIKALIEN RÉSISTANCE À L'ATTAQUE CHIMIQUE	ISO 10545.13	SECONDO I DATI DEL COSTRUTTORE ACCORDING TO BUILDERS SPECIFICATIONS LAUT ANGABEN DES HERSTELLERS SELON LES ELEMENTS DU COSTRUCTEUR	RESISTENTE RESISTANT WIDERSTEHEND RÉSISTANT	ASTM C-650	IN ACCORDANCE
RESISTENZA DEI COLORI ALLA LUCE COLOURS RESISTANCE TO LIGHT LICHTBESTÄNDIGKEIT RÉSISTANCE DES COULEURS À LA LUMIÈRE	DIN 51094	NESSUNA ALTERAZIONE NO ALTERATION KEINE VERÄNDERUNG AUCUNE ALTERATION	CONFORME IN ACCORDANCE ERFÜLLT CONFORME		
RESISTENZA ALLE MACCHIE STAIN RESISTANCE FLECKENFESTIGKEIT RÉSISTANCE AUX TACHES	ISO 10545.14	≥ CLASSE 3 METODO DI PROVA DISPONIBILE TEST METHOD AVAILABLE VERFÜGBARE PRÜFMETHODE METHODE D'ESSAI DISPONIBILE	CONFORME IN ACCORDANCE ERFÜLLT CONFORME		
RESISTENZA ALLO SCIVOLAMENTO SLIPPAGE RESISTANCE RUTSCHSICHERHEIT RÉSISTANCE AU GLISSEMENT	DIN 51130 *	9 ≤ R ≤ 13	NAT SILK ANTISLIP	R10 ASTM C-1028 * COF ≥ 0.6 DRY ≥ 0.6 WET	NAT SILK ANTISLIP
	DIN 51097 *	A,B,C	NAT SILK ANTISLIP	B ANSI * 137.1-2012 DCOF > 0.42 WET	NAT SILK ANTISLIP
	BS EN 7976-2*	> 36 DRY > 36 WET	NAT SILK ANTISLIP	Wet, Dry > 36 AS 4586: 2013 CLASS	NAT SILK ANTISLIP
			NAT SILK ANTISLIP	R11 Wet, Dry > 36	NAT SILK ANTISLIP

*TRATTANDOSI DI NORMATIVE NAZIONALI, I METODI DI PROVA, I REQUISITI E LE CLASSIFICAZIONI VARIANO DA PAESE A PAESE. IL VALORE ATTESO DALLA RESISTENZA ALLO SCIVOLAMENTO DELLA PRODUZIONE DI INDUSTRIE CERAMICHE PIEMME S.P.A., PUÒ VARIARE IN BASE AL LOTTO PRODUTTIVO. SPECIFICA DOCUMENTAZIONE È DISPONIBILE SU RICHIESTA.
TEST METHODS, REQUIREMENTS AND CLASSIFICATIONS DIFFER FROM COUNTRY TO COUNTRY, ACCORDING TO THE NATIONAL REGULATIONS. THE EXPECTED VALUE OF SLIPPAGE RESISTANCE OF PRODUCTS BY INDUSTRIE CERAMICHE PIEMME S.P.A. MAY VARY DEPENDING ON THE PRODUCTION BATCH. SPECIFIC DOCUMENTS ARE AVAILABLE UPON REQUEST.
PRÜFVERFAHREN, ERFORDERNISSE UND KLASSIFIKATIONEN SIND VERSCHIEDEN VON LAND ZU LAND, GEMÄSS DER NATIONALEN VORSCHRIFTEN. DER ERWARTUNGSWERT DER RUTSCHSICHERHEIT DER PRODUKTE VON INDUSTRIE CERAMICHE PIEMME S.P.A. KANN SICH - JE NACH DER PRODUKTIONSPARTIE - VERÄNDERN. SPEZIFISCHE UNTERLAGEN SIND AUF VERLANGEN ZUR VERFÜGUNG.
LES MÉTHODES D'ESSAI, LES RÉQUISITIONS ET LES CLASSIFICATIONS CHANGENT DE PAYS À PAYS, SELON LES RÉGLEMENTATIONS NATIONALES. LA VALEUR ATTENDUE DE RÉSISTANCE AU GLISSEMENT DES PRODUITS DE INDUSTRIE CERAMICHE PIEMME S.P.A. PEUT VARIER EN FONCTION DU LOT DE PRODUCTION. UNE DOCUMENTATION SPÉCIFIQUE EST DISPONIBLE SUR DEMANDE.

ELENCO DELLE SERIE CERTIFICATE E CLASSIFICAZIONI DISPONIBILI A RICHIESTA - LIST OF CERTIFIED SERIES AND CLASSIFICATIONS AVAILABLE UPON REQUEST
LISTE DER GEPRÜFTEN SERIE UND KLASSIFIZIERUNGEN AUF ANFRAGE ERHÄLTlich - LISTE DES SERIES CERTIFIÉES ET DES CLASSEMENTS DISPONIBLES SUR DEMANDE



CERAMICHE PIEMME
FLOOR AND MORE



Norme per la posa e la manutenzione

Installation and maintenance instructions

Verlegung, reiningung und pflege

Guide a la pose et l'entretien

- Per i prodotti rettificati consigliamo una fuga di 2 mm per un migliore risultato di posa.

- Per una migliore resa estetica Piemme consiglia stuccature colorate in tinta con le piastrelle. Verificare, prima dell'utilizzo, la compatibilità ed idoneità dei riempitivi per fughe con il prodotto ceramico.

- Rimuovere le eccedenze dei riempitivi per fughe quando gli stessi sono ancora freschi.

- Attenersi scrupolosamente alle istruzioni indicate dai produttori dei riempitivi per fughe.

- Per eliminare completamente i residui di posa, che potrebbero compromettere la manutenzione ordinaria e le caratteristiche del prodotto, a posa ultimata, procedere con la pulizia utilizzando prodotti adeguati, a base Acida max 3%, rispettando le indicazioni del produttore. Osservare assolutamente i limiti di tempo indicati nelle istruzioni: un contatto troppo pro lungato con questi prodotti potrebbe provocare il danneggiamento della superficie.

- Gli eventuali aloni che si dovessero presentare dopo la posa di materiali lappati o levigati si potranno facilmente eliminare utilizzando un prodotto idoneo, a base Alcalina.

- Riguardo l'utilizzo di materiali ceramici all'esterno, pure riconfermando l'ingelività dei prodotti Piemme in gres porcellanato, in conformità alle vigenti normative europee EN 14411/ISO 13006-ISO 10545.12, occorre attenersi ad alcune fondamentali norme previste per la posa all'esterno, atte a rendere inattaccabili al gelo i predetti pavimenti. Le condizioni più importanti da rispettare sono: le opportune pendenze, le impermeabilizzazioni, i giunti di dilatazione, e l'uso di idonei materiali per la posa.

- Decorati realizzati con smalti e metalli preziosi è indispensabile proteggere la superficie durante la posa, non utilizzare assolutamente prodotti abrasivi e/o acidi, ma solo acqua e sapone neutro. Il produttore non risponde di eventuali danni a questi preziosi materiali causati da "sfregamenti" durante la posa in opera. Per nessun motivo saranno accettate contestazioni relative a materialeposato.

TIPO DI SPORCO	INDICAZIONI PER LA PULIZIA
Birra, Caffè, Gelato, Vino Gomma Pneumatico, Grassi vegetali e animali, Inchiostri, Lampostil Olii Meccanici, Residui di scotch Olio di lino, PennarelloResine Smalti, Tintura per capelli	Prodotti a Base Alcalina
Cera protettiva anti-abrasione, Depositi calcarei, Macchie di ruggine	Prodotti a Base Acida
Cera di candela, Residui di scotch	Solventi
Per ulteriori informazioni specifiche consultare l'area tecnica sul sito Piemme: www.ceramichepiemme.it	

- For better installation results of rectified products, we suggest 2 mm joint.

- For a better aesthetic finish, Piemme recommends using jointing colours that match the tiles.

- Please check, before using, the compatibility and suitability of grouting material with the ceramic tile.

- Clean away the excess of grouting materials while they are still fresh.

- Follow carefully the instructions pointed out by the producers of tile grouting materials.

- To completely eliminate installation residues, which could negatively affect routine maintenance and product characteristics once installation has terminated, proceed to clean using adequate products, with max. 3% Acid base, following the manufacturer's instructions. Always closely abide by the time limits indicated in the instructions: prolonged contact with these products may cause damage to the surface.

- Any rims that appear after installing lapped or polished materials can be easily eliminated using a suitable Alkaline-based product.

- With regard to the use of ceramic materials outdoors, while once more reiterating that Piemme porcelain stoneware products are frost-proof, in compliance with applicable European standards EN 14411/ISO 13006-ISO 10545.12, a number of fundamental procedures must be followed for outdoor installation, suitable for making the aforementioned floors resistant to frost. The most important aspects are: suitable gradients, waterproofing, expansion joints, and the use of suitable installation materials.

- Decorations made with glazes and precious metals It is most important to protect the surface during installation. Never use abrasive and/or acid products, only water and neutral soap. The manufacturer disclaims liability in case of any damage to these precious materials caused by "rubbing" during installation. Under no circumstances will disputes be accepted relating to the installed material.

TYPE OF STAIN	CLEANING SUGGESTIONS
beer, coffee, wine, ice cream vegetable and animal fats, rubber, remains of scotch tape, grease from machines, linseed oil, felt tip pens, paints, inks, hair dye	Alkaline-based detergent
protective anti-abrasion wax, calcareous residuals, rust stains	Acid-based detergent
candle wax, remains of scotch-tape	Solvents
For further specific details please visit the technical area on Piemme website: www.ceramichepiemme.it	

- Damit sich eine bessere Verlegung von geschliffenen Produkten ergibt, empfehlen wir eine Fugenbreite von 2 mm.Für ein optisch perfektes Ergebnis empfiehlt Piemme, die Fugen farblich auf die Fliesen abzustimmen.

- Prüfen sie bitte, vor der Verwendung, die Zweckmäßigkeit und die Verträglichkeit des Fugenfüllmittels mit den Keramikfliesen.

- Bitte entfernen sie das überflüssige Fugenfüllmittel wenn es noch frisch ist.

- Folgen sie bitte sorgfältig die von dem Herstellern des Fugenfüllmittels angegebenen Bedienungsvorschriften.

- Zur vollkommenen Entfernung der Verlegerückstände, die die normale Pflege erschweren und die Merkmale des Produkts beeinträchtigen könnten, nach der Verlegung geeignete Reinigungsmittel auf max. 3% Säurebasis verwenden und bei der Reinigung die Hinweise des Herstellers beachten. Die angegebenen Zeiten keinesfalls überschreiten: ein zu lange andauernder Kontakt mit diesen Produkten kann Beschädigungen der Oberfläche verursachen.

- Eventuelle nach der Verlegung von geläppter oder geschliffenem Material sichtbare Schleier lassen sich einfach mit entsprechenden, alkalischen Produkten entfernen.

- Auch wenn die Piemme-Feinsteinzeugprodukte gemäß den europäischen Normen EN 14411/ISO 13006-ISO 10545.12 frostbeständig sind, müssen beim Einsatz keramischer Materialien im Freien einige Grundregeln beachtet werden, damit die Bodenbeläge nicht vom Frost angegriffen werden können. Die wichtigsten Voraussetzungen sind: korrektes Gefälle, Abdichtung, Dehnungsfugen sowie geeignetes Verlegematerial.

- Dekore mit Glasuren und Edelmetallen Während der Verlegung muss die Oberfläche unbedingt abgedeckt werden. Es dürfen keine scheuernden und/oder säurehaltigen Produkte verwendet werden, sondern ausschließlich Wasser und neutrale Seife. Der Hersteller haftet nicht für eventuelle, während der Verlegung durch Abrieb entstandene Schäden an diesen hochwertigen Materialien. Reklamationen von bereits verlegtem Material werden in keinem Fall akzeptiert.

VERSCHMUTZUNGSART	REINIGUNGSHINWEISE
Bier, Wein, Eis, Kaffee Tierische oder pflanzliche Fette Gummi, Kleberbandresten Schmieröl, Tinte, Leöl, Filzstift, Harz oder Lack, Haarfarbe	Alkalische Reinigungsmittel
Kratzenschutz-Wachs, Kalkablagerunge, Rostflecken	Säure-Reinigungsmittel
Kerzenwachs Kleberbandresten	Lösungsmittel
Weitere Einzelheiten finden Sie in dem technischen Bereich des Piemme website: www.ceramichepiemme.it	

- Pour obtenir le meilleur résultat de pose de produits rectifiés, il est conseillé de réaliser un joint de 2 mm.

- Pour parfaire l'effet esthétique obtenu, Piemme conseille de confectionner des joints de la même couleur que les carreaux.

- Vérifier avant la pose la compatibilité et convenance des remplissages pour joints avec le produit céramique.

- Enlever les surplus des remplissages pour joints alors qu'ils sont encore frais.

- Respecter scrupuleusement les instructions indiquées par les fabricants de remplissages pour joints.

- Pour éliminer complètement tout résidu de pose pouvant gêner l'entretien courant et altérer les caractéristiques du produit, il est conseillé, à la fin de la pose, de procéder au nettoyage du carrelage avec des produits à base acide maximum 3% et de respecter les consignes du fabricant. Suivre impérativement les délais indiqués dans la notice car le contact trop prolongé de ces produits pourrait endommager la surface.

- Pour éliminer facilement la présence éventuelle de cernes après la pose de carreaux rodés ou polis, utiliser un produit à base alcaline.

- Pour ce qui est de la pose à l'extérieur, bien que les produits Piemme en grès cérame soient ingélifs, conformément aux normes européennes EN 14411/ISO 13006-ISO 10545.12, il convient cependant de respecter quelques règles fondamentales de manière à rendre le carrelage inattaquable au gel. Les conditions les plus importantes à remplir sont: le degré d'inclinaison, l'imperméabilisation, les joints de dilatation et l'utilisation de matériaux de pose appropriés.

- Décors réalisés avec des émaux et des métaux précieux Il est indispensable de protéger la surface pendant la pose. N'utiliser en aucun cas des produits abrasifs et/ou acides mais uniquement de l'eau et du savon neutre. La fabricant ne répond pas des dommages éventuels de ces matériaux précieux causés par le frottement pendant la pose. Aucune réclamation, quelle qu'elle soit, concernant le matériau posé ne sera acceptée.

TYPE DE TACHE	NETTOYAGE CONSEIL
Bière, Vin, Glace, Café, Graisses végétales et animales, Encres, Résidus de scotch, Huile de graissage, Hile de lin Crayon feutre Émaux, Teinture pour cheveux, Caoutchouc pour pneus	Détergents à base alcaline
Cire de protection anti abrasion, Dépôts de calcaire, Tache de rouille	Détergents à base d'acide
Cire de bougie Résidus de scotch	Solvant
Pour d'ultérieures Information spécifiques consulter le département technique du site Piemme: www.ceramichepiemme.it	

Guida alla Lettura

Reading Guide

Leseanleitung

Guide à la lecture

▼
▲
Spessore
Thickness
Stärke
Epaisseur

Variazione nelle sfumature di colore
Color shade variations
Variation der Farbnuancen
Variation des nuances de couleur

Resistenza alla scivolosità
Skid resistance
Rutschfestigkeit
Resistance au glissement

V1

Aspetto uniforme
Uniform apperance
Gleichförmiges aussehen
Aspect uniforme

V2

Variazione leggera
Slight variation
Leichte variation
Variation légère

V3

Variazione moderata
Moderate variation
Mäßige variation
Variation modeste

V4

Variazione casuale
Random variation
Zufällige variation
Variation fortuite

Tutti i formati sono nominali.

All sizes are nominal.

Die Formate sind Nennwerte.

Tous les formats sont nominaux.

Gli spessori riportati in questo catalogo sono nominali e possono variare a seconda dei formati e delle finiture.

The thickness mentioned on this catalogue are nominal and can be different according to the sizes and the finishes.

Die in diesem Katalog angegebenen Fliesenstärke sind nominal und können, je nach Format oder Oberfläche, verschieden sein.

Les épaisseurs reportées sur ce catalogue sont nominales et peuvent varier suivant les formats et les finitions.

I colori e le caratteristiche estetiche dei prodotti sono quanto più possibile vicini a quelli reali, nei limiti consentiti dai processi di stampa.

The colours and appearance features of the products are as close as possible to reality, within the limitation of the printing process.

Die Farben und die ästhetischen Eigenschaften der Produkte entsprechen der Wirklichkeit, innerhalb den von dem Druckverfahren erlaubten Grenzen.

Les couleurs et les caractéristiques esthétiques sont fidèles aux couleurs et caractéristiques réelles dans les limites des procédés d'impression.



Ceramics of Italy rappresenta la volontà dell'industria italiana delle piastrelle di ceramica nel diffondere e promuovere una nuova valenza della piastrella di ceramica: non più solo un prodotto per l'industria delle costruzioni, ma punto di riferimento per stile e creatività per lo sviluppo di una nuova cultura dell'abitare Made in Italy.

Ceramics of Italy represents the willingness of the Italian ceramic tile industry to spread and promote a new concept of ceramic tile: no longer just a product for the construction industry, but a focal point for style and creativity in the development of a new culture of living Made in Italy.

Project Management
Mktg Piemme

Febbraio 2023
February 2023

Una storia tutta italiana

Piemme dal 1962, anno della sua fondazione, è protagonista indiscussa del vero Made in Italy, quello fatto di eccellenza, passione e creatività. Oggi tutti i materiali Piemme sono prodotti con tecnologia d'avanguardia come la decorazione digitale inkjet HD, la cottura in forni ad energia pulita a recupero di calore, la rettifica e levigatura in linea "one roof" e la verifica elettronica dello standard qualitativo.

An all-Italian story

Since 1962, the year of its foundation, Piemme has been the undisputed protagonist of real Made in Italy, that which consists of excellence, passion and creativity. Today, all Piemme materials are made using cuttingedge technology such as HD inkjet digital decoration, firing in heat-recycling cleanenergy kilns, "one roof" grinding and polishing line and electronic quality standard control.

Eine ganz italienische Geschichte

Seit dem Gründungsjahr 1962 ist Piemme ein unangefochtener Hauptakteur des echten Made in Italy: jenem, das auf Exzellenz, Leidenschaft und Kreativität gründet. Alle Piemme Erzeugnisse werden heute unter Einsatz von Spitzentechnologie produziert, wie zum Beispiel mit der digitalen Inkjet-Dekoration, dem Brennen in Öfen mit grüner Energie und Wärmerückgewinnung, dem Schleifen und Polieren in der Linie „unter einem Dach“ sowie der elektronischen Prüfung des Qualitätsniveaus.

Une histoire toute italienne

Depuis 1962, l'année de sa fondation, Piemme est la protagoniste indiscutée du Made in Italy, basé sur l'excellence, la passion et la créativité. Aujourd'hui toutes les phases du cycle de fabrication Piemme sont issues d'une technologie à l'avant-garde comme la décoration numérique inkjet HD, la cuisson dans des fours à énergie propre et à récupération de chaleur, la rectification et le polissage en en ligne "one roof" et la vérification électronique de la qualité.

CERAMICHE PIEMME

FLOOR AND MORE

INDUSTRIE CERAMICHE PIEMME S.P.A.
VIA DEL CROCIALE 42/44, 41042 FIORANO (MO) - ITALY
T. +39 0536.849111 - F. +39 0536.849402
WWW.CERAMICHEPIEMME.IT - INFO@CERAMICHEPIEMME.IT